











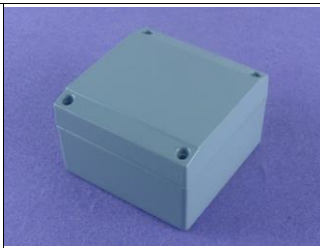





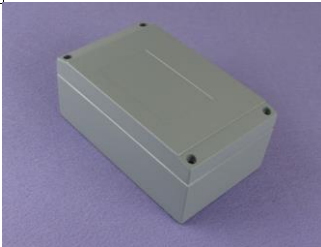
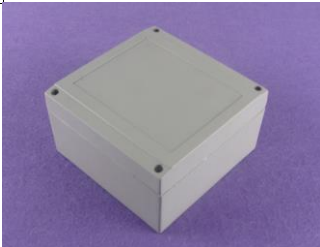

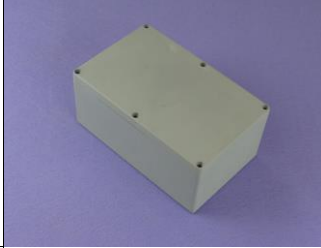

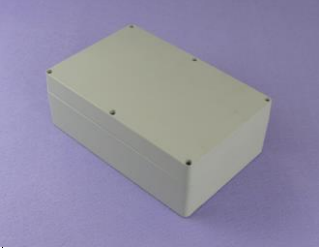
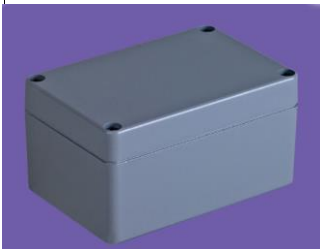





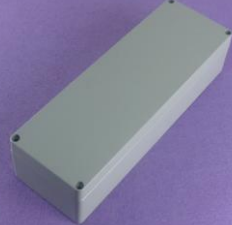
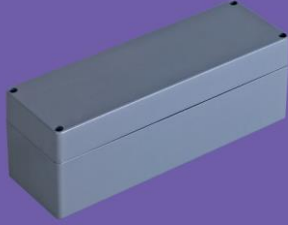













KLS ELECTRONIC CO.,LTD













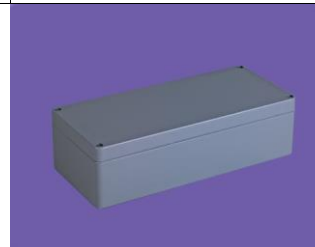





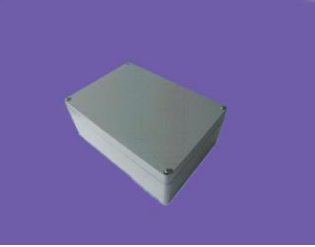
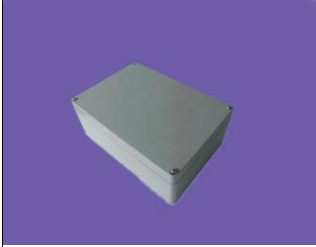

AWP SERIES LIST

			
code: AWP005 size: 63X58X37	code: AWP010 size: 80X75X58	code: AWP013 size: 100X100X60	code: AWP015 size: 110X64X37
			
code: AWP020 size: 115X65X55	code: AWP025 size: 120X80X55	code: AWP026 size: 120X80X57	code: AWP030 size: 120X80X65
			
code: AWP035 size: 150X64X36	code: AWP040 size: 160X100X65	code: AWP042 size: 140X140X75	code: AWP043 size: 140X140X100
			
code: AWP045 size: 175X80X57	code: AWP050 size: 188X120X78	code: AWP055 size: 222X145X58	code: AWP060 size: 222X145X75
			





AWP SERIES LIST

code: AWP061 size: 150x100x80	code: AWP062 size: 120x80x65 mm	code: AWP063 size: 90x36x31 mm	code: AWP065 size: 252X157X72
			
code: AWP066 size: 252X157X55	code: AWP068 size: 360X120X80	code: AWP071 size: 250x80x64	code: AWP073 size: 160x160x85
			
code: AWP074 size: 185x135x85	code: AWP075 size: 220x155x95	code: AWP076 size: 250x190x90	code: AWP078 size: 250x190x92
			
code: AWP100 size: 240x160x100	code: AWP105 size: 260x160x90	code: AWP115 size: 100X68X50	code: AWP125 size: 115X90X56
			
code: AWP205 size: 230X163X68	code: AWP220 size: 230X150X74	code: AWP245 size: 105X95X65	code: AWP247 size: 100x56x56
			
code: AWP505 size: 120X120X80	code: AWP510 size: 235X155X90	code: AWP511 size: 260x160x90	code: AWP512 size: 220x120x90
			

AWP SERIES LIST

code: AWP513 size: 270x120x90	code: AWP514 size: 250x80x80	code: AWP515 size: 160X160X90	code: AWP520 size: 98X64X34
			
code: AWP521 size: 330x230x180	code: AWP522 size: 175x80x80	code: AWP523 size: 230x200x110	code: AWP524 size: 360x160x90
			
code: AWP525 size: 330x230x120	code: AWP526 size: 185x65x45	code: AWP529 size: 100x100x60	code: AWP530 size: 138x112x62
			
code: AWP531 size: 165x140x65	code: AWP533 size: 200X130X80	code: AWP535 size: 260X185X96	code: AWP537 size: 295*210*100
			
code: AWP539 size: 340X235X160	code: AWP541 size: 295X210X120	code: AWP330 size: 128X88X50	code: AWP335 size: 125X94X78
			
code: AWP340 size: 160X110X60	code: AWP345 size: 167X83X84	code: AWP347 size: 170X85X90	code: AWP350 size: 210X130X60
			

AWP SERIES LIST

<p>code: AWP365 size: 280X200X90</p>	<p>code: AWP366 size: 310x220x100</p>	<p>code: AWP370 size: 255X150X90</p>	<p>code: AWP375 size: 260X145X100</p>
			
<p>code: AWP380 size: 202X168X113</p>	<p>code: AWP435 size: 210X130X60</p>	<p>code: AWP440 size: 148X98X43</p>	<p>code: AWP506 size: 120X120X80</p>

RoHS Compliance

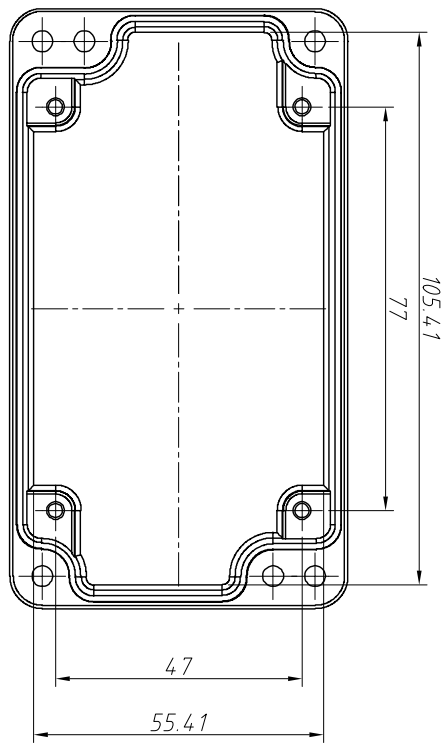
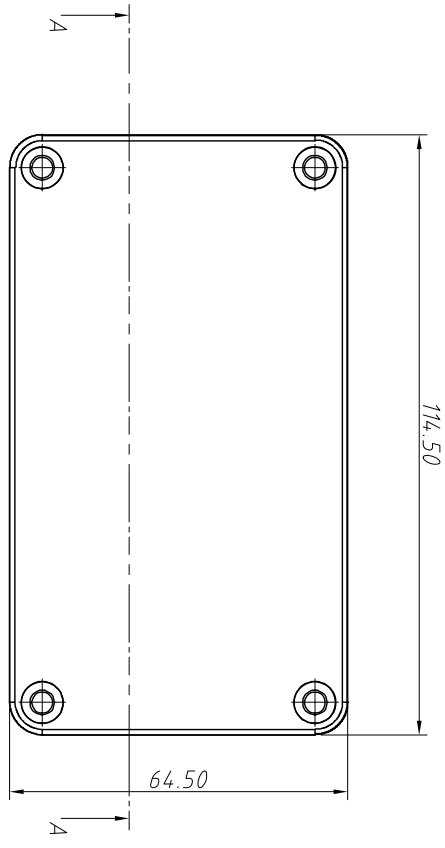

Material:
Housing: Aluminium, Natural

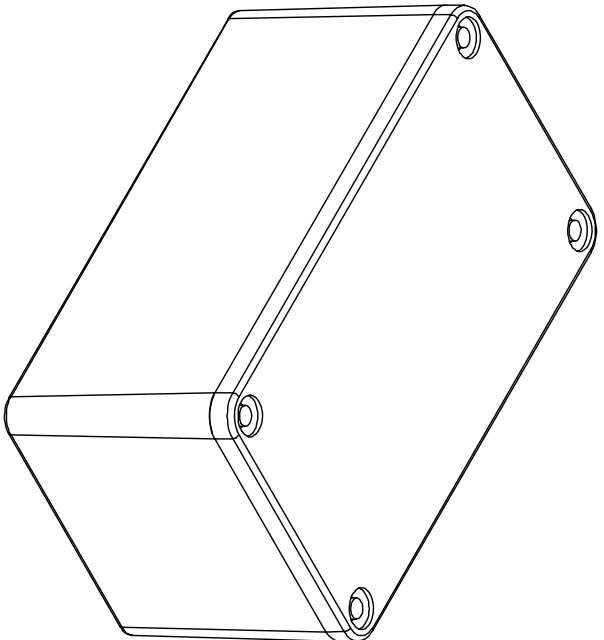
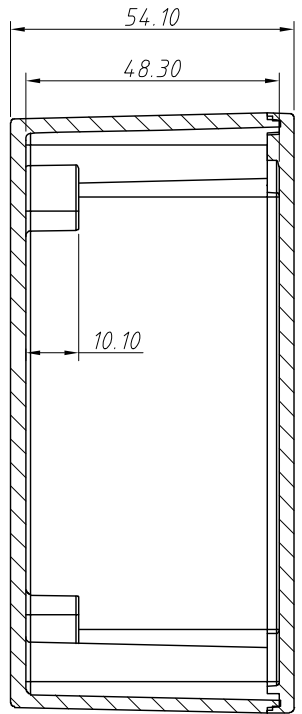

SECTION A-A

ANGLE TOLERANCE

$\pm 3^\circ$

PROJECTION



Description:

Die cast aluminum waterproof box

GENERAL TOLERANCE

UNITS

SHEET SIZE

Check:

.x ± 0.30
.xx ± 0.20
.xxx ± 0.10

mm

A4

WuHao

Daniel

2024-12-11

2024-12-11

KLS P./N:

L-KLS24-AW/P020



NingBo KLS ELECTRONIC CO.,LTD.

REV	SYM	Revision Record	Appr.	Date
V0	KLS01242	New Version Release	WuHao	2024-12-11